

SERIE BBC

- BENNA BIVALVE PER CARICO MATERIALI VARI
- GRAB FOR DIFFERENT MATERIALS LOADING
- BENNE DOUBLE-COQUILLES POUR CHARGEMENT MATÉRIAUX DIFFÉRENTS
- ZWEISCHALENGREIFER FÜR VERLADUNG VON VERSCHIEDENEN MATERIALIEN
- TWEESCHALENGRIJPER VOOR OVERSLAG VAN DIVERSE MATERIALEN

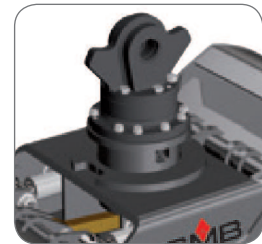

Rotatore Indexator
Hydraulic rotators indexator





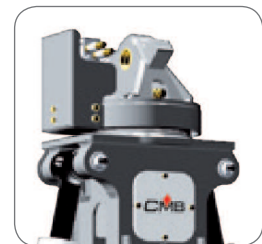



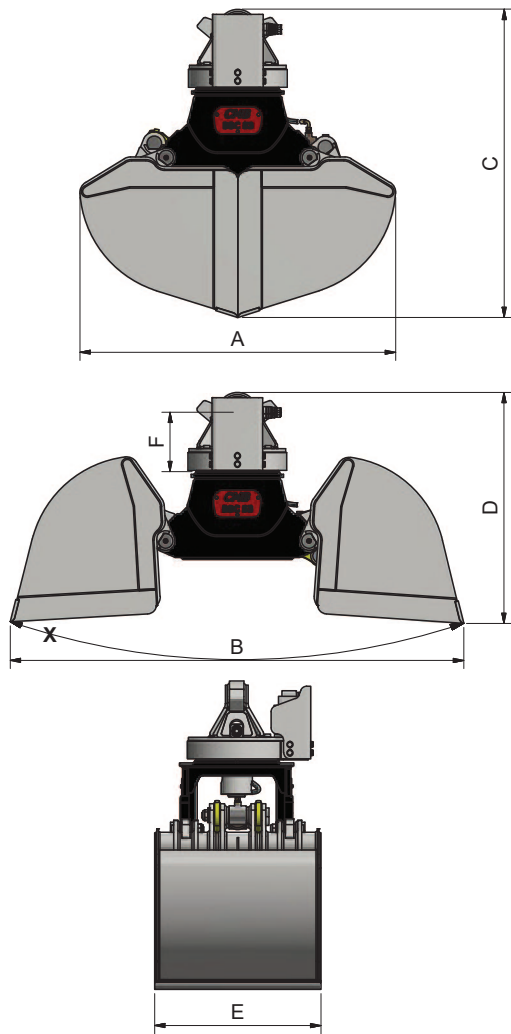

Girevole con ralla GR
Hydraulic GR rotators



		BBC 48 300	BBC 48 400	BBC 48 500	BBC 53 600	BBC 53 800	BBC 53 1000
CAP.	m ³	0,3	0,4	0,5	0,56	0,8	1
	Kg	340	450	480	700	850	1130
	ton	6-12	6-12	6-12	12-20	12-20	12-20
A	mm	1200	1200	1200	1520	1520	1520
B	mm	1700	1700	1700	2200	2200	2200
C	mm	1180	1180	1180	1490	1490	1490
D	mm	940	940	940	1120	1120	1120
E	mm	450	600	750	800	1000	1300
F	mm	333	333	333	333	390	390
X	ton	4	4	4	4,15	4,15	4,15
	bar	280	280	280	280	280	280
	l/min	70	70	70	80	80	80
	model	GR 5	GR 5	GR 5	GR 5	GR 10	GR 10
	model	GV 12 S	GV 12 S	GV 12 S	GV 12 S	-	-
	model	-	-	-	-	IR 10	IR10

MOVING EQUIPMENT



		BBC 63 1300	BBC 63 1600	BBC 63 1800	BBC 70 2200	BBC 70 2500
CAP.	m ³	1,3	1,6	1,8	2,2	2,5
	Kg	1530	1600	1650	1900	2160
	ton	18-26	18-26	18-26	22-28	22-28
A	mm	1840	1840	1840	2150	2150
B	mm	2200	2200	2200	2500	2500
C	mm	1590	1590	1590	1650	1650
D	mm	1450	1450	1450	1500	1500
E	mm	1300	1600	1800	1800	2000
F	mm	390	390	390	400	400
X	ton	4,8	4,8	4,8	7	7
	bar	280	280	280	280	280
	l/min	100	100	100	160	160
	model	GR 10	GR 10	GR 10	GR 20	GR 20
	model	-	-	-	-	-
	model	IR 10	IR 10	IR 10	IR 20	IR 20